

QUIRK BOOKS

2025 Bologna Rights Guide



CONTENTS

BOARD BOOKS

Dog and Cat's First Series by Natalie Nelson

Dog Loves Baby	3
Cat's First Halloween	4
Dog's First Christmas	4
Cat's First Baby	4
Dog's First Baby	4

Let's Find Series by Andrew Knapp

Let's Find Yaya and Boo On The Go	5
Let's Find Momo Everywhere	6
Let's Find Yaya and Boo At Home	6
Let's Find Momo Outdoors	6
Let's Find Momo	6

PICTURE BOOKS

Seasons Series by Jaimie MacGibbon

Snuggle Season	8
Swimming Season	8

CHAPTER BOOKS

Zoomi & Zoe Series by Corey Ann Haydu

Zoomi and Zoe and the Tricky Turnaround	10
Zoomi and Zoe and the Sibling Situation	10

MIDDLE GRADE FICTION

A Brush with Magic by Flora Ahn	11
A Spoonful of Time by Flora Ahn	11
The Secrets of Underhill by Kali Wallace	12
Hunters of the Lost City by Kali Wallace	12
Nick and Tesla Series by "Science Bob" Pflugfelder and Steve Hockensmith	13
Warren the 13th Series by Tania del Rio and Will Staehle	14

MIDDLE GRADE NONFICTION

Growing into You! by Melissa Pintor Carnagey	15
The Worst-Case Scenario Survival Handbook for Kids! by David Borgenicht and Justin Heimberg	16

Totally Factual Field Guides to the Supernatural by Insha Fitzpatrick

Swimming with Sea Monsters	17
Sightseeing with Aliens	18
Hanging with Vampires	18
Chilling with Ghosts	18

Kid Legends Series by Robin Stevenson

Kid Olympians: Winter	19
Kid Musicians	20
Kid Activists	20
Kid Artists	20
Kid Athletes	20
Kid Authors	20
Kid Innovators	20
Kid Olympians: Summer	20
Kid Scientists	20
Kid Trailblazers	20

Little Kid, Big City! Series	21
Pet That Cat by Nigel Kidd and Rachel Braunigan	22
Pet That Dog by Gideon Kidd and Rachel Braunigan	22
The Wild World Handbook: Habitats by Andrea Debbink	22
The Wild World Handbook: Creatures by Andrea Debbink	22

YOUNG ADULT NONFICTION

Girls Resist! by KaeLyn Rich	23
Wonder Women by Sam Maggs	24
Girl Squads by Sam Maggs	24
The Fangirl's Guide to the Universe by Sam Maggs	24

YOUNG ADULT FICTION

Gay the Pray Away by Natalie Naudus	25
Stars, Hide Your Fires by Jessica Mary Best	26
You Pierce My Soul by Jessica Mary Best	26
Lycanthropy and Other Chronic Illnesses by Kristen O'Neal	27
Once Upon a Con Series by Ashley Poston	28
This Is Not the Jess Show Duology by Anna Carey	28
Miss Peregrine's Peculiar Children Series by Ransom Riggs	29



DOG LOVES BABY

by Natalie Nelson
In the next book in the beloved board book series from Natalie Nelson, Dog and Baby are back with a sweet ode to what it means to love someone all year long!
December 2, 2025
Page 3



CAT'S FIRST HALLOWEEN

by Natalie Nelson
It's Spooky Season, and Cat is ready to show Baby everything he knows about it! Celebrate Halloween with Cat, tricks, and treats as Baby discovers what makes the season so special!
August 12, 2025
Page 4



LET'S FIND YAYA AND BOO ON THE GO!

by Andrew Knapp
Cars, trucks, Yaya, and Boo! Play hide-and-seek with two lovable dogs and twelve exciting vehicles in Andrew Knapp's latest board book.
September 16, 2025
Page 6



SNUGGLE SEASON

by Jaimie MacGibbon
Curl up with a soft blanket and hot cocoa to read this cozy, wintry picture book—the first in a new series capturing the simple joys and daily rituals of each changing season.
October 14, 2025
Page 7



ZOOMI AND ZOE AND THE TRICKY TURNAROUND

by Cori Ann Haydu, illustrated by Anne Appert
Written by the acclaimed Corey Ann Haydu with sweet, quirky illustrations by Anne Appert, the Zoomi and Zoe series explores the wonder and anxiety of life's first big transitions with warmth, whimsy, and plenty of silliness.
June 3, 2025
Page 10

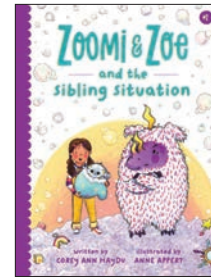

ZOOMI AND ZOE AND THE SIBLING SITUATION

by Cori Ann Haydu, illustrated by Anne Appert
Zoomi and Zoe were proud to conquer their first Tricky Turnaround together, but the second book in the series brings more changes for the new friends: Zoomi and Zoe are both going to be big siblings!
August 19, 2025
Page 10

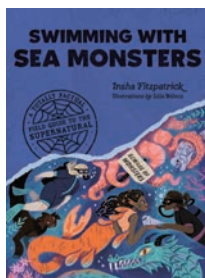

SWIMMING WITH SEA MONSTERS

by Insha Fitzpatrick
Set sail for adventure with this illustrated guide to sea monsters and the ocean, featuring cool science, fascinating history, and hands-on activities—perfect for readers age 8-12!
August 26, 2025
Page 17

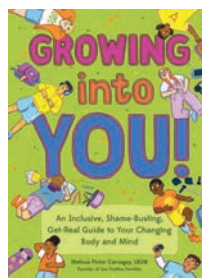

GROWING INTO YOU!

by Melissa Pintor Carnagey, illustrated by Brianna Gilmartin
For tweens of all gender identities ages 10 to 14 and their trusted caregivers, *Growing into You!* is a shame-busting, interactive guide to puberty and changing bodies by the founder of Sex Positive Families.
May 6, 2025
Page 15



GAY THE PRAY AWAY

by Natalie Naudus
In this gripping queer YA romance perfect for fans of Casey McQuiston and Becky Albertalli, an Asian American teen longs to break free of the conservative cult she was raised in.
May 20, 2025
Page 25



Dog and Baby are back with a sweet ode to love!

Dog Loves Baby

By Natalie Nelson

In the next book in the beloved board book series from Natalie Nelson, Dog and Baby are back with a sweet ode to what it means to love someone all year long! In the next book in the beloved board book series from Natalie Nelson, Dog and Baby are back with a sweet ode to what it means to love someone all year long! Simple rhyming text and bright illustrations make *Dog Loves Baby* an ideal gift for the youngest readers.

Love is in the air! In this sweet book, Dog sniffs out the meaning of “love” and tries to figure out why there are so many paper hearts to chew, too. Of course, Baby is on the case, too—and they just might discover that love is all around them, even if they aren’t allowed to eat the chocolate they find. Dog sniffs out the meaning of “love,” and tries to figure out why there are so many paper hearts to chew, too. Of course, Baby is on the case, too—and they just might discover that love is all around them, even if they aren’t allowed to eat the chocolate they find.

For more in this beloved series, delight in new experiences any time of the year with *Dog’s First Baby* and *Cat’s First Baby*, and celebrate the Winter holiday spirit with *Dog’s First Christmas!*



NATALIE NELSON is an illustrator, picture book maker, and collage artist. Her previous titles include, *Dog’s First Baby*, *Cat’s First Baby*, and *Holiday!*. She lives in Atlanta, Georgia, with her family, and you can visit her online at natalieknelson.com.

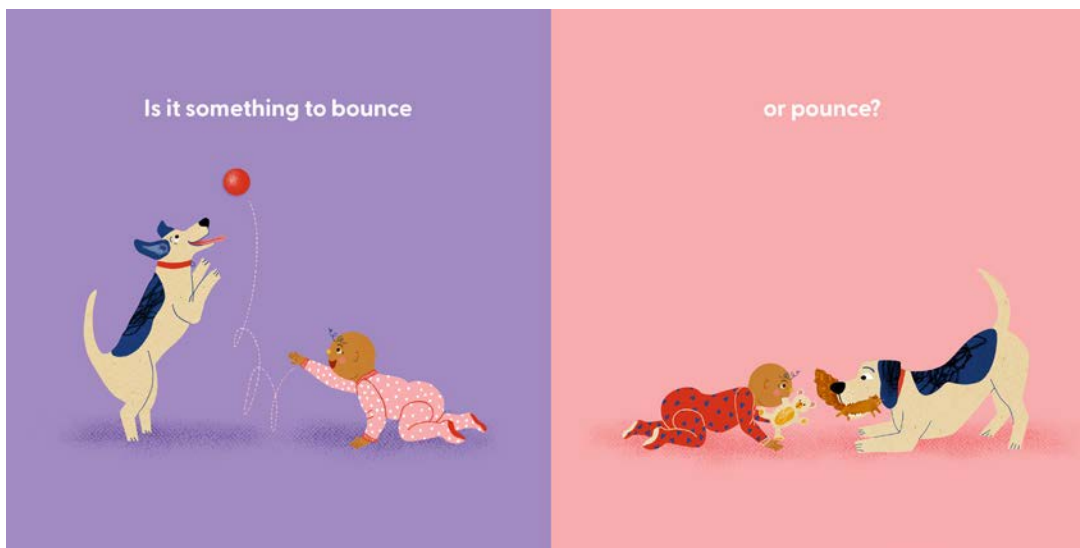

Subject:

Juvenile Fiction - Holidays & Celebrations - Valentine’s Day
 Juvenile Fiction - Animals - Dogs
 Juvenile Fiction - Animals - Pets

ISBN: 978-1-68369-452-6

\$9.99 USD

Reading Level and Age Range: 2-5 years

7 x 7, 28 spreads
 Board

Rights: All World Rights Available.

Publication Date: December 2, 2025

Final PDF Available: June 2025

Sample Manuscript Available: April 2025

ABOUT THE SERIES

Dog is curious, and Cat is skeptical. Whether they're meeting a new baby or celebrating a holiday or milestone, you can count on Dog and Cat to sniff out answers and find wonder in new experiences in this playful board book series for babies and toddlers by Natalie Nelson. Coming soon: *Cat's First Halloween*, *Dog Loves Baby*, and *Cat's First Day of School!*



Dog's First Baby

October 2021

Rights Sold: French (Le Père Castor)

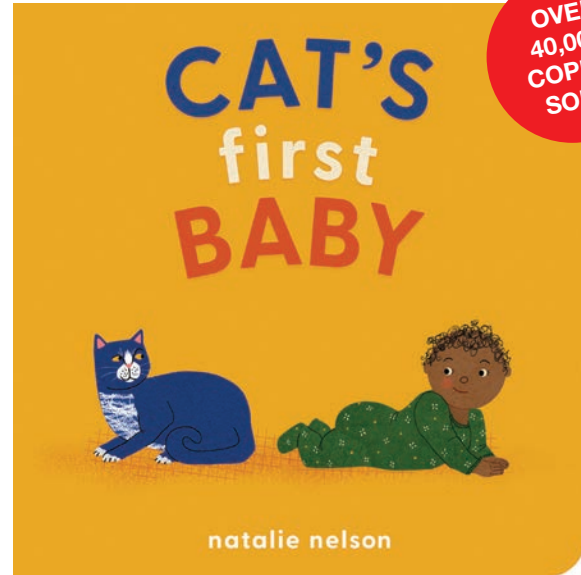

Cat's First Baby

March 2022

All World Rights Available



Dog's First Christmas

October 2024

All world rights available.



Cat's First Halloween

August 12, 2025

All world rights available.



Let's Find Yaya and Boo on the Go!

By Andrew Knapp

Cars, trucks, Yaya, and Boo!

Is that Yaya taking a ride in a fire truck, and Boo hiding behind a boat? Can you spot the dogs taking a bus ride to school, or checking out a construction site? The next installment of Andrew Knapp's beloved Find Momo series highlights things that go, such as cars, trucks, airplanes, bikes, and more!

Search for Yaya and Boo in unlikely places all over town and learn new words by finding objects in each lovingly photographed scene packed with delightful details.



ANDREW KNAPP is a writer, illustrator, graphic designer, and photographer currently based in Vancouver. Previous books include *Let's Find Momo!*, *Let's Find Momo Outdoors!*, *Let's Find Yaya and Boo at Home!*, and *Find Momo Everywhere*. Say hello at letsfindmomo.com.

PLAY HIDE-AND-SEEK WITH TWO LOVABLE DOGS AND TWELVE EXCITING VEHICLES IN THE LATEST BOARD BOOK BY ANDREW KNAPP!

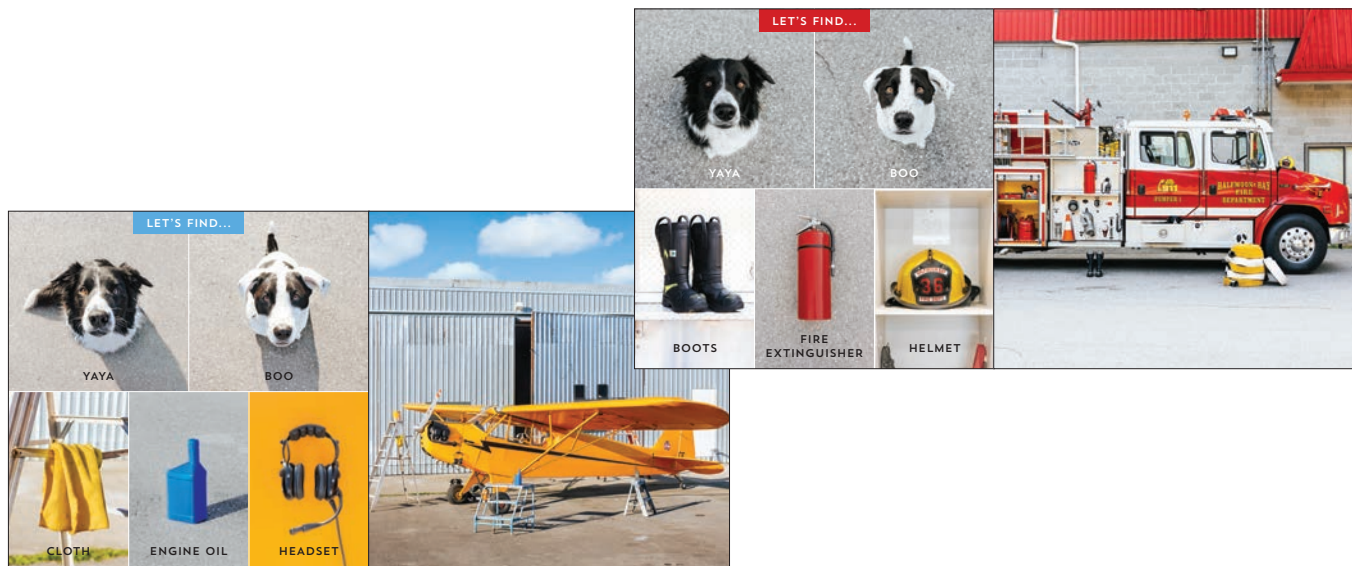

Subject:
 Juvenile Nonfiction - Animals - Dogs
 Juvenile Nonfiction - Games & Activities - General
 Juvenile Nonfiction - Transportation - General

ISBN: 978-1-68369-486-1
 \$10.99 USD
 8 x 8, 24 pages
 Board
Reading Level and Age Range: 2-5

Rights Sold:
 French (Grandes Personnes)

Publication Date: September 16, 2025
Final PDF Available: Available Now

ABOUT THE SERIES

Momo, Yaya, and Boo love to play hide-and-seek with you! Look for these adorable pup pals hiding in joyful scenes photographed by their best friend, Andrew Knapp.



OVER
120,000
COPIES
SOLD

Let's Find Momo!

April 2017
Dutch (WPG Kindermedia), Estonian (Koolibri), French (Grandes Personnes), German (Fischer), Italian (Topipittori), Polish (Lumi)



OVER
65,000
COPIES
SOLD

Let's Find Momo Outdoors!

May 2021
French (Grandes Personnes), Italian (Topipittori), Polish (Lumi)



OVER
20,000
COPIES
SOLD

Let's Find Yaya and Boo At Home!

August 2023
French (Grandes Personnes), Polish (Lumi)



OVER
7,500
COPIES
SOLD

Find Momo Everywhere

February 2024
Simplified Chinese (Jiangsu Phoenix Children's Publishing House)

THIS TIME OF YEAR: A NEW PICTURE BOOK SERIES!

About the books

Embrace the rhythm of the seasons with this celebration of the best each time of year has to offer: **Snuggle Season, Growing Season, Swimming Season, and Sweater Season.**

Some books focus all their seasonal attention on holidays and their respective traditions, rituals, and preparations. Others work to shape young readers' understanding of months and calendars and how the seasons connect with so many other aspects of our natural world. *Snuggle Season* and the subsequent books highlight the cozy daily rituals that mark our lives, and especially children's lives. In *Snuggle Season* delight in the coziness of winter! In *Growing Season*, celebrate the wonders of spring! In *Swimming Season*, dive into the joys of summer! In *Sweater Season*, embrace the crisp, cool days of autumn!

JAIMIE MACGIBBON is a children's book author and illustrator living in the mountains of British Columbia, Canada, where she gets to experience the full range of seasons. From waist-deep snow, to mud and blossoms, to scorching summers and golden autumns, Jaimie looks forward to celebrating each new season with her family. This is her author-illustrator debut.

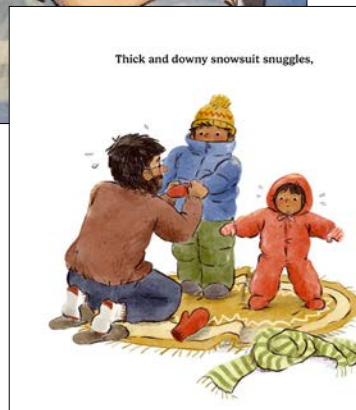

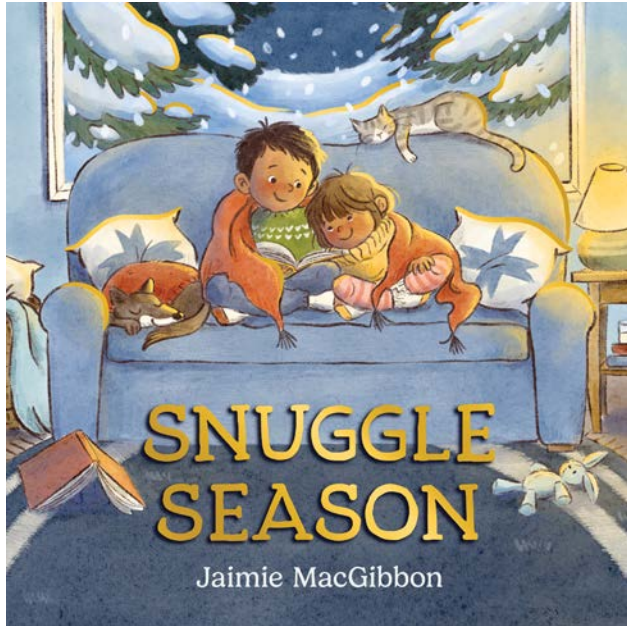

Snuggle Season

By Jaimie MacGibbon

Curl up with a soft blanket and hot cocoa to read this cozy, wintry picture book—the first in a new series capturing the simple joys and daily rituals of each changing season.

Can't get out of bed snuggles, curled up by the fire snuggles, waiting for the baking snuggles, and cuddled round a book snuggles: delight in the coziness of winter with *Snuggle Season*!

A simple but magical day unfolds as two siblings wake up to chilly temperatures and falling snow, taking the opportunity to snuggle up in bed, eat warm oatmeal for breakfast, play outside in a snowy fort, and sit by the fire with their animal friends.

Featuring Jaimie MacGibbon's warm, rhythmic text and inviting illustrations, *Snuggle Season* highlights the memorable daily rhythms of childhood—and through them, sweet assurances of love—that emerge as the seasons shape our lives. This is a timeless read-aloud sure to become a family favorite each year when *Snuggle Season* rolls around.



Swimming Season

By Jaimie MacGibbon

Splash into summer with a picture book about joyful seasonal rituals!

Warm sand, splashing water, and sunny weather: it's time for *Swimming Season*! An ode to the magic of endless summer days, Jaimie MacGibbon's rhythmic text and joyful illustrations celebrate the best that summer has to offer.

Swimming Season is the second book in a timeless new series about the memorable daily rhythms of childhood—and through them, sweet assurances of love—that emerge as the seasons shape our lives.

A pitch-perfect read-aloud, this story is sure to become a family favorite each year when the temperatures rise.

Snuggle Season

Subject:

Juvenile Fiction - Concepts - Seasons
 Juvenile Fiction - Social Themes - New Experience
 Juvenile Fiction - Family - General

ISBN: 978-1-68369-512-7

\$18.99 USD

9 x 9, 32 pages,
 4c hardcover with jacket

Age Range: 2-5

Rights Sold: All world rights available.

Publication Date: October 14, 2025

Final PDF Available: May 2025

ARC PDF Available: March 2025

Swimming Season

Subject:

Juvenile Fiction - Concepts - Seasons
 Juvenile Fiction - Social Themes - New Experience
 Juvenile Fiction - Family - General

ISBN: 978-1-68369-516-5

\$18.99 USD

9 x 9, 32 pages,
 4c hardcover with jacket

Age Range: 2-5

Rights Sold: All world rights available.

Publication Date: April 14, 2026

Final PDF Available: November 2025

ARC PDF Available: August 2025

A NEW EARLY READER SERIES FOR AGES 4-8!

The Princess in Black meets *Monsters, Inc.* in this whimsical, zany illustrated early chapter book series about an unlikely friendship between a glittery monster, Zoomi, and her new imaginary friend—a human named Zoe. This topsy-turvy series will gently explore life’s first big transitions—like friends moving away, new siblings, and the loss of a pet—with humor, heart, and magic.

In *Zoomi and Zoe and the Tricky Turnaround* (June 2025), Zoomi and Zoe each navigate tricky friendship dynamics as old friends move away and they get to know each other in this new world.

In *Zoomi and Zoe and the Sibling Situation* (August 2025), there are more changes for the new friends: Zoe is going to be a big sister, and Zoomi’s family is welcoming a new baby, too!



COREY ANN HAYDU is the author of many critically acclaimed middle grade and young adult novels, including *Eventown*, *Lawless Spaces*, *Ever Cursed*, and *One Jar of Magic*. She is also the author of the Hand-Me-

Down Magic chapter book series and the upcoming picture book *A Place for Feelings*. Corey is a graduate of NYU’s Tisch School of the Arts and The New School’s Writing for Children MFA program, and a faculty member of the Vermont College of Fine Arts’ MFA in Writing for Children and Young Adults program. She lives in Brooklyn with her husband and two young daughters.

ANNE APPERT is a storyteller who uses whimsy and humor to inspire and connect with readers on their own journeys toward becoming their most authentic selves. Anne went to the Fashion Institute of Technology for a BFA in illustration with a minor in English so they could bring their stories to life. Their first book was *Blob*, a picture book about being yourself. Their second book, *What If You Wish?*, is a picture book about the power of perseverance and wonder. Anne hopes to inspire all kids through fun and imaginative storytelling to dream big and love themselves. You can visit Anne at anneappert.com.

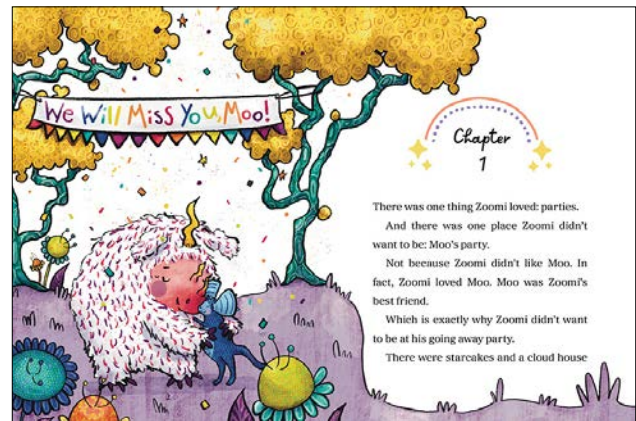

Chapter 1

There was one thing Zoomi loved: parties. And there was one place Zoomi didn’t want to be: Moo’s party. Not because Zoomi didn’t like Moo. In fact, Zoomi loved Moo. Moo was Zoomi’s best friend. Which is exactly why Zoomi didn’t want to be at his going away party. There were starcakes and a cloud house

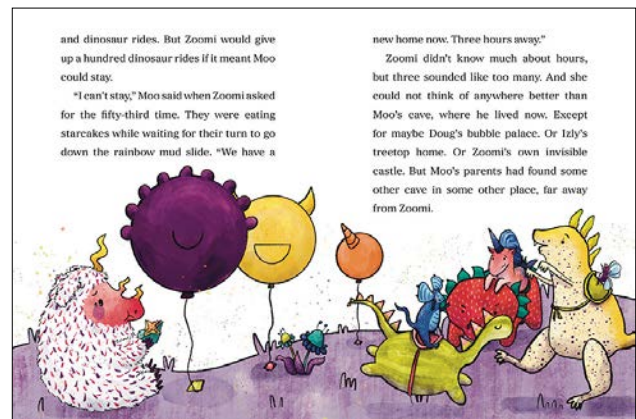

and dinosaur rides. But Zoomi would give up a hundred dinosaur rides if it meant Moo could stay.

“I can’t stay,” Moo said when Zoomi asked for the fifty-third time. They were eating starcakes while waiting for their turn to go down the rainbow mud slide. “We have a

new home now. Three hours away.”

Zoomi didn’t know much about hours, but three sounded like too many. And she could not think of anywhere better than Moo’s cave, where he lived now. Except for maybe Doug’s bubble palace. Or Izzy’s treetop home. Or Zoomi’s own invisible castle. But Moo’s parents had found some other cave in some other place, far away from Zoomi.



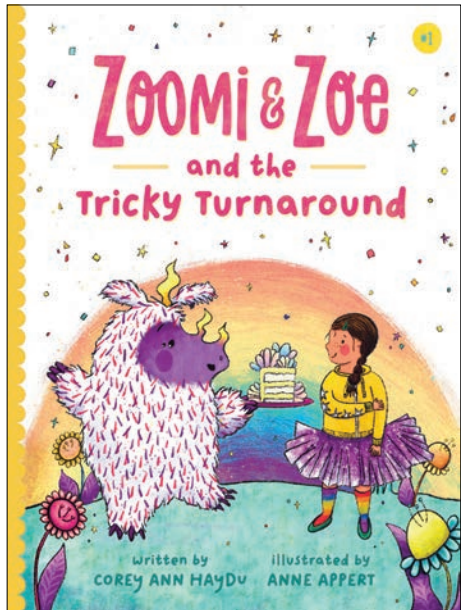

Zoomi and Zoe and the Tricky Turnaround

By Corey Ann Haydu, illustrated by Anne Appert

Zoe loves routine, her stuffed rhino Zoomi, and her best friend Kyla. When Kyla moves away, Zoe feels alone. Until somehow, she's transported to a magical new world with just one sort-of-familiar face: Zoomi, who is suddenly very much real.

Zoomi loves adventure, zooming, and her best friend Moo. In her world, life is full of happy surprises, but one ritual is certain: when something hard happens, she'll have Tricky Turnaround. And when she does, a Happy Helpful Human from the "real" world will arrive to help her through it.

But when Zoe arrives, she doesn't seem very happy. Or helpful. Or interested in the party Zoomi threw for her—complete with toothbrushes and a rainbow mud slide. In fact, Zoe may be navigating a Tricky Turnaround of her own. Can Zoomi and Zoe come together to help each other with the trickier parts of growing up, like saying goodbye to friends and making new ones?

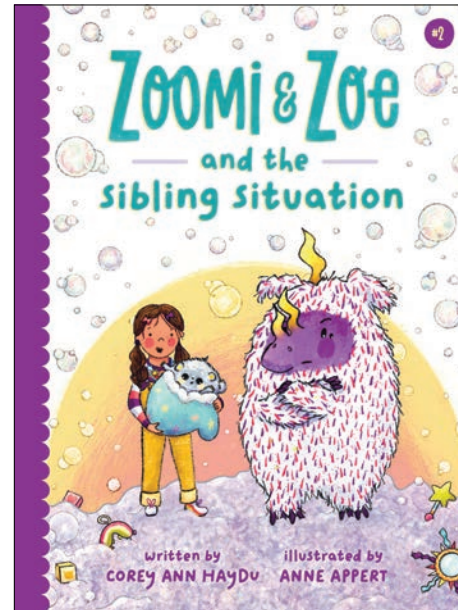

Zoomi and Zoe and the Sibling Situation

By Corey Ann Haydu, illustrated by Anne Appert

The second book in the series brings more changes for the new friends: Zoomi and Zoe are both going to be big siblings!

Zoomi and Zoe were proud to conquer their first Tricky Turnaround together . . . but the transitions keep coming! This time, Zoomi's mom brings home a new baby, who is—in Zoomi's humble opinion—very boring, and kind of rude. Meanwhile, Zoe's dads have a wonderful surprise: Zoe is going to be a big sister, too! But Zoe's new brother doesn't seem to like her very much. Why does he keep crying when Zoe is around?

Fortunately, Zoomi and Zoe have a plan: Baby School! With help from Izly and Doug, these unlikely friends are positive they can teach their new siblings how to be better babies—starting with how to sing the alpha-bing, and how to appreciate their big sisters. But teaching Baby School isn't as easy as it sounds. Can Zoomi and Zoe come to terms with the changes in their families, and even learn a thing or two about these loud, smelly creatures along the way?

Enter through the Pineapple Portal to join Zoomi and Zoe in their second adventure, and keep an eye out for the other books in this zany, hilarious new series for emerging readers: *The Tricky Turnaround* (book one), and *Zoomi and Zoe and the Camp Catastrophe* coming June 16, 2026.

Zoomi and Zoe and the Tricky Turnaround

Subject:
Juvenile Fiction - Social Themes - Friendship
Juvenile Fiction - Social Themes - New Experience
Juvenile Fiction - Fantasy & Magic

ISBN: 978-1-68369-458-8
\$15.99 USD

6 x 8, 96 pages,
4c unjacketed hardcover

Age Range: 4–8
Rights Sold:
Audio: Dreamscape
Translation: Available from Quirk
Film/TV: Reserved by Author (High Line Literary)

Publication Date: June 3, 2025
Final PDF Available: Available Now

Zoomi and Zoe and the Sibling Situation

Subject:
Juvenile Fiction - Social Themes - Friendship
Juvenile Fiction - Social Themes - New Experience
Juvenile Fiction - Fantasy & Magic

ISBN: 978-1-68369-460-1
\$15.99 USD

6 x 8, 96 pages,
4c unjacketed hardcover

Age Range: 4–8
Rights Sold:
Audio: Dreamscape
Translation: Available from Quirk
Film/TV: Reserved by Author

Publication Date: August 19, 2025
ARC PDF Available: Available Now



A Spoonful of Time

By Flora Ahn

“Full of twists, this middle grade story is a heartwarming mix of food and family.”—Kirkus Reviews

When You Reach Me meets Love Sugar Magic in this unforgettable middle grade novel where time travel, family recipes, and family secrets collide.

Maya’s grandmother, Halmunee, may be losing her memory, but she hasn’t lost her magic touch in the kitchen. When she serves salty miyeok-guk or sweet songpyeon, her stories about Korea come to life for Maya.

Then one day, something extraordinary happens: one delicious bite transports Maya and Halmunee into one of Halmunee’s memories. Suddenly they’re in Seoul, and Halmunee is young.

This is just the first of many secrets Maya will uncover: that she and her grandmother can travel through time. As Maya eats her way through the past, her questions multiply—until a shocking discovery transforms everything she thought she knew about family, friendship, loss, and time itself.

Brimming with heart and interspersed with seven family recipes that readers can make themselves, this is a story to savor by rising Korean American author Flora Ahn.



A Brush with Magic

By Flora Ahn

“Fantastical elements are seamlessly woven into this engaging, entertaining story A universal coming-of-age tale becomes extraordinary through an encounter with Korean folk magic.”

—Kirkus Reviews, ★ starred review

A heartfelt, magical middle grade adventure—inspired by Korean folklore and set in modern-day Seoul—about sisterhood and belonging, perfect for fans of Kelly Yang and Janae Marks.

It’s finally summer break, and twelve-year-old Yumi is headed to Korea with her older sister, Minji, for the very first time. She can’t wait to explore the city of Seoul together—but Minji has other plans. The moment they land, Minji ditches Yumi to hang out with their cousins, who are more fashionable, better at soccer, and all-around cooler than Yumi. Lost and alone, Yumi is stuck at home painting with her grandfather.

Everything changes when she finds an intriguing ink brush in a neighborhood art shop—and she accidentally summons a creature straight out of her grandfather’s retellings of Korean fairy tales. With a new friend by her side and an ink brush that has the power to bring anything she paints to life, Yumi feels unstoppable. From bustling street markets and ancient palaces to riding the subway, Yumi and her friend explore everything Seoul has to offer.

But when the magic takes a dark turn, Yumi must dig deep to hear her own voice and protect the family she loves—even if they don’t always understand each other.



FLORA AHN is an attorney by day and an author and illustrator by night. Her work includes a children's chapter book series, Pug Pals (Scholastic), and an Audible Original, *The Golden Orchard*. Raised in California by her Korean immigrant parents, Ahn lives in Virginia with her two pugs and practices law in Washington, DC.

A Spoonful of Time

ISBN: 978-1-68369-497-7

\$8.99 USD

5½ x 8, 272 pages,
1c paperback

Word Count: Approx. 50,000 words

Age Range: 8–12 years

Publication Date: April 2023

Rights Sold: Korean (Hello Robin),
Turkish (Timaş), Audio (Blackstone)

A Brush with Magic

ISBN: 978-1-68369-320-8

\$16.99 USD

5½ x 8, 288 pages,
1c hardcover with jacket and spot
illustrations

Word Count: Approx. 50,000 words

Age Range: 8–12 years

Publication Date: October 2024

Rights Sold:
Audio: (Dreamscape), Turkish (Timaş)



Hunters of the Lost City

By Kali Wallace

“Reminiscent in feel to Kelly Barnhill’s *The Girl Who Drank the Moon*, this lovely fantasy introduces a complicated, brave, and believable heroine. . . . An absolute delight.”
—*Kirkus Reviews*, starred review

Packed with shocking twists, frightening monsters, and dark magic, this is a page-turning fantasy adventure for middle-grade fans of Holly Black and Tamora Pierce.

Twelve-year-old Octavia grew up believing the town of Vittoria was the only one left in the world. The sole survivors of a deadly magical war and plague, the people of Vittoria know there’s no one alive outside the town walls—except the terrible monsters that prowl the forest.

But then the impossible happens: Octavia meets another girl beyond the walls, someone who isn’t Vittorian. Everything she’s ever believed is thrown into question, and there’s no going back.

In her quest for the truth, Octavia discovers a world full of lies, monsters, and magic. She’ll have to use every scrap of her skill, wits, and courage to uncover what’s real about Vittoria and the rest of the world.



The Secrets of Underhill

By Kali Wallace

An eleven-year-old apprentice fights to save an ancient grove of magical trees that hold the key to her community’s survival in this page-turning fantasy adventure. Perfect for middle grade fans of Kelly Barnhill and Jessica Townsend.

Nick Sixsmith has spent her whole life on the road. The daughter of a traveling arborist, she moves with her mother from town to town, caring for the ironwood groves the communities rely upon. When a dangerous blight takes hold of these magical trees, they must journey to the city of Mistwood—her mother’s hometown—for answers.

Nick can’t wait to explore the prosperous city of Mistwood and all it has to offer: bustling markets and workshops, neighborhoods built under a roaring waterfall, and the vast ancestral grove of ironwood trees. But dark secrets simmer beneath the surface as people start to disappear and tensions rise in the city.

As the mystery grows, Nick and her new friends from Mistwood must follow the trail where it leads them: underground, to a strange, enchanting world called Underhill. Only there, among the roots of the ancestral grove, will Nick find a way to save her new home and the ironwood trees.

This immersive fantasy adventure combines vivid world-building with timely themes of environmentalism, and young readers will be riveted until the final page.



KALI WALLACE is the author of books for children and adults, including *City of Islands*, *Shallow Graves*, and *Salvation Day*. She lives in Portland, Oregon.

Hunters of the Lost City

ISBN: 978-1-68369-289-8

\$16.99 USD

5½ x 8, 304 pages

1c hardcover with jacket

Word Count: Approx. 70,000 words

Age Range: 10 and up

Publication Date:

April 2022

Rights Sold: Audio (Blackstone),
Korean (Gravity Books)

The Secrets of Underhill

ISBN: 978-1-68369-388-8

\$17.99 USD

5½ x 8, 320 pages,

1c hardcover with jacket

Age Range: 10 and up

Word Count: Approx. 70,000 words

Publication Date: January 2025

Rights Sold: All world rights available.

Nick and Tesla Series

When their parents send them to spend the summer with their eccentric uncle, twins Nick and Tesla Holt use science to solve mysteries and save the day. Each of their adventures features laugh-out-loud jokes, fun illustrations, and DIY science projects for readers to try at home.

150,000 COPIES SOLD!

EACH BOOK INCLUDES FIVE DO-IT-YOURSELF SCIENCE PROJECTS DRAWN FROM THE STORY!

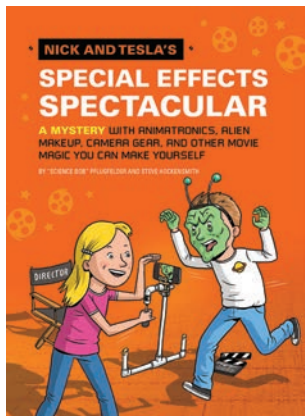
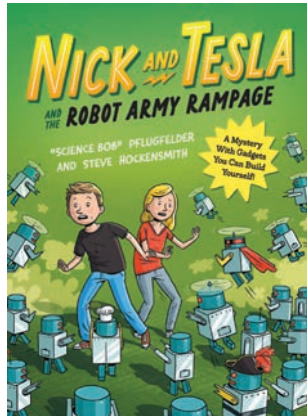
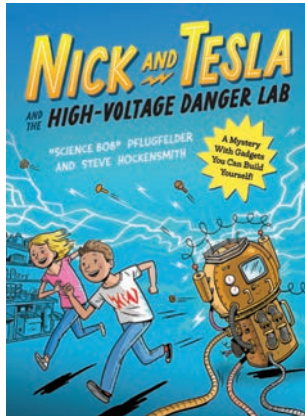

ISBN 978-1-68369-379-6 Nick and Tesla and the High-Voltage Danger Lab
 ISBN 978-1-68369-390-1 Nick and Tesla and the Robot Army Rampage
 ISBN 978-1-68369-403-8 Nick and Tesla and the Secret Agent Gadget Battle
 ISBN 978-1-68369-405-2 Nick and Tesla and the Super-Cyborg Gadget Glove
 ISBN 978-1-59474-760-1 Nick and Tesla's Special Effects Spectacular
 ISBN 978-1-59474-866-0 Nick and Tesla's Solar-Powered Showdown

\$8.99 USD
 5½ x 7½, 224–288 pages, 1c paperback
 Age Range: 8–12 years
 Approx. 40 illustrations and 40,000 words

“SCIENCE BOB” PFLUGFELDER is a teacher who loves building fun gadgets that he shares on television and online.

STEVE HOCKENSMITH is a *New York Times* best-selling author and mystery writer.

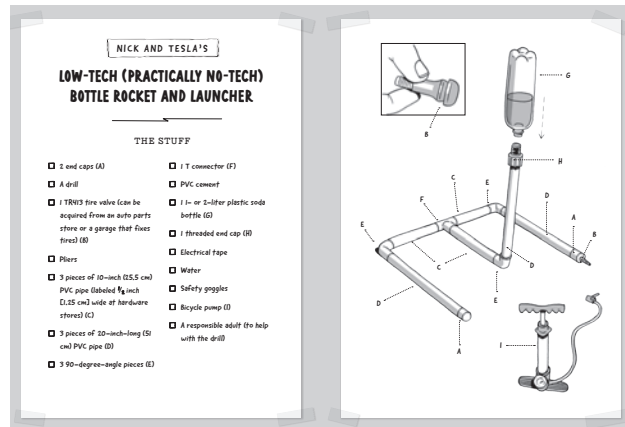

"No!" said Nick. "No, no, no!"

Despite the bungled launch, the rocket was flying faster and higher than they ever could have hoped. Which was the problem. Instead of going straight up and coming straight down, the bottle, weighted down by its unintended cargo, was arcing to the right. As it plummeted to earth again, it was headed for the trees on the edge of the field.

Nick started running after it. "If it lands in the top branches we'll never get it down!"

"Don't freak out," Tesla grumbled. She took a quick test-suff of her hair and grimaced. "It's not going fast enough to go as far as . . . oh."

The rocket zipped over the trees and landed with a little hollow *thud* on the wrong side of the tall fence surrounding the Old Whoever Place.

"Oh, no," Nick moaned as he trotted up to the fence. He put his hands on the crisscrossing wires and stared forlornly at the *Albert and Martha Holt*. "Should I climb over and get it?"

"Go for it," Tesla said. "And for the next launch, you get to pour the stink-water into the . . . Nick, look out!"

Two large dark shapes appeared on the other

Warren the 13th Series

A strange-looking kid with a heart of gold, fastidious orphan Warren has one dream: to restore his family's creepy old hotel to its former glory. But to do that, he has to contend with mysterious visitors, secret codes, hidden maps, weird creatures, and angry witches. Luckily Warren has friends to help him, including a witch-in-training, a circus strongman turned chef, a reclusive professor, and a friendly monster named Sketchy.

“An engaging mystery to unravel, with a few nice twists and surprises along the way.”

—*New York Times Book Review*

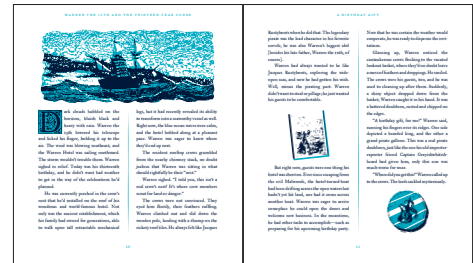
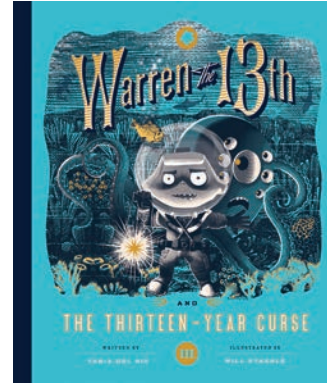

Warren the 13th and the All-Seeing Eye

A beautifully illustrated, action-packed middle grade adventure in the spirit of Edward Gorey and Lemony Snicket.

Warren the 13th is the lone bellhop, valet, groundskeeper, and errand boy of his family's ancient hotel. The strange, shadowy mansion is full of crooked corridors and mysterious riddles—and it just might be home to a magical treasure known as the All-Seeing Eye. But if Warren is going to find the hidden treasure, he'll need to solve several other mysteries first: What is the strange creature lurking in the hotel boiler room? Who is the ghostly girl creeping around the garden's hedge maze? And why is the hotel's only guest covered in bandages?

Publication Date: November 2015
ISBN 978-1-59474-803-5
 \$16.95 USD
 7½ x 8½, 224 pages,
 2c unjacketed hardcover

Age Range: 10 and up
Rights Sold: Basque, Bulgarian, Catalan, Chinese-S, Czech, Estonian (Expired), Finnish, French (Expired), German (Expired), Greek, Hungarian (Expired), Italian, Korean (Expired), Lithuanian (Expired), Persian, Polish (Expired), Portuguese in Brazil (Expired), Romanian, Russian, Serbian (Expired), Slovak (Expired), Spanish in Spain, Spanish in LatAm, Thai, Turkish



TANIA DEL RIO is the author of the Warren the 13th series. A professional comic book writer and artist, her clients include Archie Comics, Dark Horse, and Marvel.



WILL STAEHLE is the illustrator and designer of the Warren the 13th series, plus dozens of award-winning book jackets.

Warren the 13th and the Whispering Woods

Twelve-year-old Warren has learned that his beloved hotel can walk, and now it's ferrying guests around the countryside, transporting tourists to strange and foreign destinations. But when an unexpected detour brings everyone into the dark and sinister Malwoods, Warren finds himself separated from his hotel and his friends—and racing after them on foot through a forest teeming with witches, snakes, talking trees, and mind-boggling riddles.

Publication Date: March 2017
ISBN 978-1-59474-929-2
 \$16.95 USD
 7½ x 8½, 240 pages,
 2c unjacketed hardcover

Age Range: 10 and up
Rights Sold: Basque, Bulgarian, Catalan, Chinese-S, Czech (Expired), Estonian, Finnish, French (Expired), Greek, Hungarian, Korean (Expired), Persian, Romanian, Russian, Slovak (Expired), Spanish in Europe, Spanish in LatAm, Thai

Warren the 13th and the Thirteen-Year Curse

In this final story of Warren's thrilling adventures, the young manager is adjusting to the demands of running a floating hotel and is planning his thirteenth birthday party. But then disaster strikes! The Warren Hotel is shipwrecked on a strange island, and Sketchy is kidnapped!

Warren and his crew of friends set off on a daring rescue mission across the high seas where they meet a delightful new cast of characters that includes wizened pirates, a sea witch, and a talking clam. As Warren pursues his many-tentacled friend's kidnappers, he will learn the truth of Sketchy's mysterious origins—as well as one final secret of his beloved Warren Hotel.

Publication Date: March 2020
ISBN 978-1-68369-090-0
 \$16.99 USD
 7½ x 8½, 224 pages,
 2c unjacketed hardcover

Age Range: 10 and up
Rights Sold: Basque, Bulgarian, Catalan, Chinese-S, Czech, Finnish, Hungarian, Persian, Russian, Slovak, Spanish-Eur, Spanish-LatAm, Thai

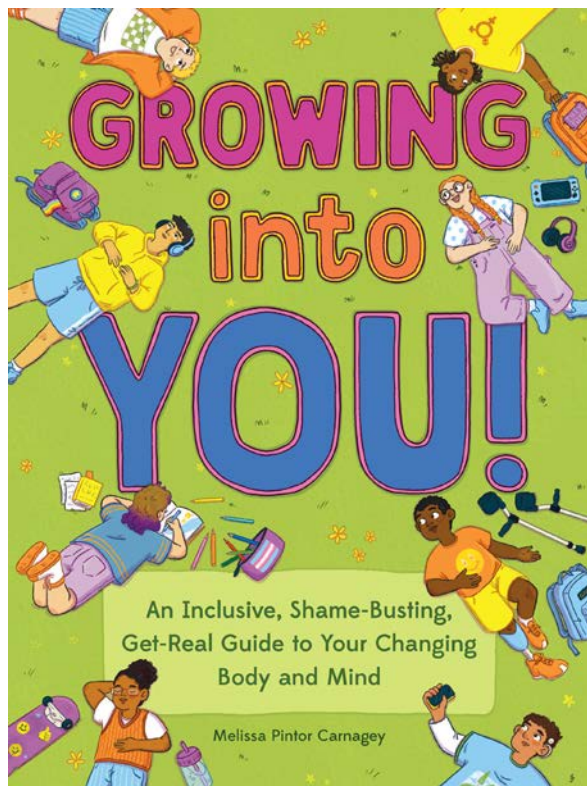

Growing into You!

An Inclusive, Shame-Busting, Get-Real Guide to Your Changing Body and Mind

By Melissa Pintor Carnagey; Illustrated by Brianna Gilmartin

For tweens of all gender identities ages 10 to 14 and their trusted caregivers, *Growing into You!* is a shame-busting, interactive guide to puberty and changing bodies by the founder of Sex Positive Families.

Body hair. Changing friendships. Weird fluids. The tween years can be awkward and confusing—but with enough information and an open mind, you can thrive!

Growing Into You! has all the facts you're looking for and more. For example, did you know that . . .

- Voice changes happen to people of all genders?
- Breast buds aren't just something girls develop?
- Sleep actually helps your body grow bones and muscles?
- Everyone has their own unique relationship to gender?

By the founder of Sex Positive Families, a groundbreaking education platform dedicated to shame-free, inclusive conversations around bodies and sexuality, *Growing Into You!* is a modern primer on the puberty years for Generation Alpha.

Packed with essential information, conversation starters, reflection exercises, surprising facts, and fun activities, the book contains plenty for you to take into the real world with you.

This valuable resource for families aims to change the conversation around puberty, from a trailblazer in sexual health education and the founder of the popular Sex Positive Families online platform.



MELISSA PINTOR CARNAGEY, LBSW (she/they) is a Black, Puerto Rican, and Mexican sexuality educator and licensed social worker who believes that all children deserve holistic, comprehensive, and shame-free sexuality education. Her professional experience spans 15 years in the field of sexual health. She is the creator of the Growing Into You!™ virtual puberty education program, and is based out of Austin, Texas.

BRIANNA GILMARTIN enjoys creating work that is full of silly and imaginative fun and reflective of quieter moments of life, as well as more emotional work that studies the human condition, human emotions, and our need for human connection.



Subject:
 Juvenile Nonfiction - Health & Daily Living
 - Maturing
 Juvenile Nonfiction - Social Topics - New Experience
 Juvenile Nonfiction - Science & Nature - Anatomy & Physiology

ISBN: 978-1-68369-431-1
\$17.99 USD
 6½ x 8¾, 176 pages
 4c paperback
Age Range: 10-14

Rights:
Translation: Available from Quirk
Audio: Under negotiation
Film/TV: Retained by author

Publication Date: May 6, 2025
Final PDF Available: Available Now

The Worst-Case Scenario Survival Handbook For Kids

By David Borgenicht and Justin Heimberg; Illustrated by Wenke Kramp

Erupting volcanoes. Ravenous sharks. Pooping in the woods.

The great outdoors is a weird, wonderful, and scare-your-pants-off terrifying place. Whether you're freezing in the Arctic, escaping quicksand in the jungle, or befriendng tarantulas in the desert, this guide has you covered. (Figuratively, not literally. We didn't have the budget for a blanket-sized book.)

Bust this guide open and discover step-by-step instructions for surviving the most extreme situations that Planet Earth can throw at you. Learn how to:

- Dodge a charging rhinoceros
- Ride out a sandstorm
- Navigate by the stars
- Build a snow cave
- Cross piranha-infested waters
- And much more!

Yeah, the outdoors can be scary, but you've got this indispensable, laugh-out-loud survival guide. So what are you waiting for? Get out there!



DAVE BORGENICHT, is the coauthor of all the books in the Worst-Case Scenario Survival Handbook series and the founder of Quirk Books. He knows how to float on quicksand, jump from a moving car, and properly groom a gorilla. He lives in Philadelphia.

JUSTIN HEIMBERG defines the word extreme. He is extremely cautious and wary. He is an extreme sleeper and an extreme television watcher. On the rare occasion when Justin is not being extreme, he writes books and films. He lives in an extreme suburb in Maryland.



WENKE KRAMP is an illustrator from Berlin, Germany.

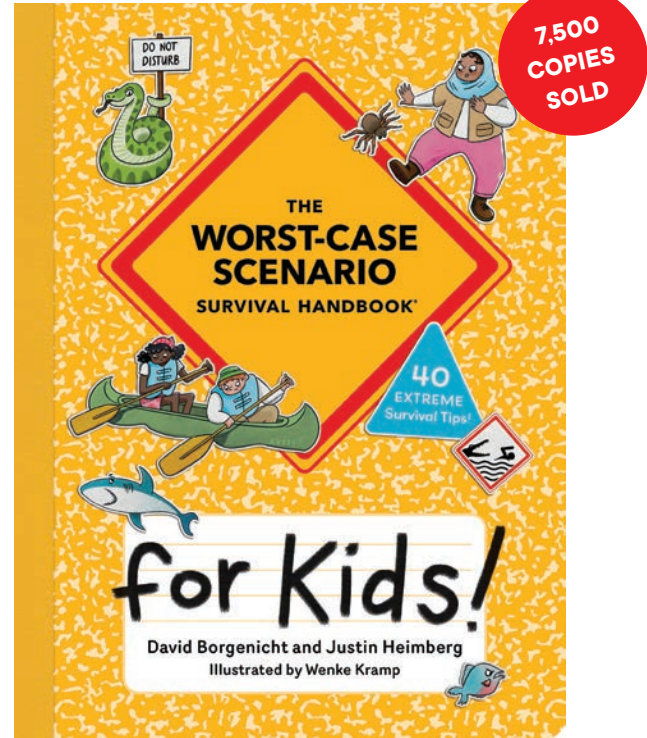

A 2024 NATIONAL PARENTING PRODUCT AWARDS WINNER

The best-selling (and wildly hilarious) Worst-Case Scenario series is back with 40 extreme survival tips for kids ages 8 to 12, great for adventurous fans of the I Survived series.

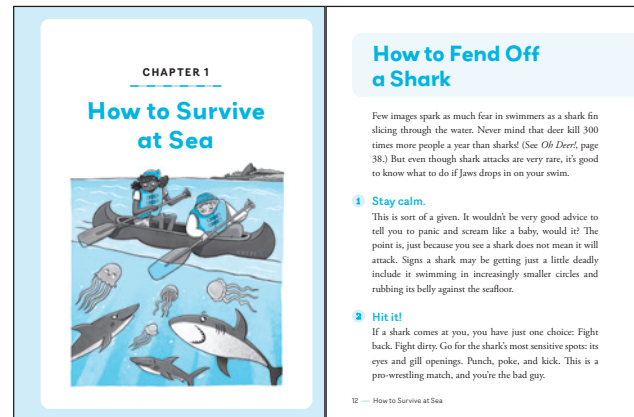

Subject:
 Juvenile Nonfiction - Adventure & Adventurers
 Juvenile Nonfiction - Science & Nature - Disasters
 Juvenile Nonfiction - Humor

ISBN: 978-1-68369-456-4
 \$12.99 USD
 6 x 8, 128 pages
 2c paperback with spot illustrations throughout
Age Range: 8-12

Rights:
Translation: Korean (GrassAndWind Publishing)
Audiobook: Available from Quirk
Film/TV: Available from Quirk

Publication Date: September 2024

Swimming with Sea Monsters

A Totally Factual Field Guide to the Supernatural
By Insha Fitzpatrick, illustrated by Lilla Bölecz

Set sail for adventure with this illustrated guide to sea monsters and the ocean, featuring cool science, fascinating history, and hands-on activities—perfect for readers age 8-12!

The fourth book in the Totally Factual Field Guide to the Supernatural series, *Swimming with Sea Monsters* is a funny and informative non-fiction guide to how myths and legends are shaped by the world around us.

Ahoy there! Ever wonder how deep the ocean is? Curious about what sea creatures—real and legendary—swim beneath the waves? Want to know how we can protect the coral reefs? Dive into *Swimming with Sea Monsters* and discover:

- **Fascinating science and fun facts about the ocean!** Descend to the depths of the ocean and meet creatures like the colossal squid and the anglerfish.
- **Eye-opening history and ancient mythology!** Get to know the sea monsters in *The Odyssey* and pirate queen Zheng Yi Sao.
- **Nautical fiction and enchanting fairy tales!** Read up on legends of sea monsters from around the world and the classic fairy tale *The Little Mermaid*.

Learn all about the ocean and sea monsters with charming illustrations and hands-on activities you can try at home, like creating a zine about ocean conservation and building a beach terrarium! The whole world is out there—grab your guide, and let’s go!

For more fun and educational field guides, check out *Hanging with Vampires*, *Chilling with Ghosts*, and *Sightseeing with Aliens!*



INSHA FITZPATRICK is a New Jersey-based author who loves all things horror. She’s the writer of *Who Sparked the Montgomery Bus Boycott: Rosa Parks (Who HQ)*, illustrated by Abelle Hayford. She’s also the coauthor of the middle grade graphic novel series *Oh My Gods!* with Stephanie Cooke and illustrator Juliana Moon. When she’s not writing, she’s watching horror movies or reality TV and deep-diving into all things true crime.



LILLA BÖLECZ is a Hungarian graphic artist and illustrator whose passion is creating peculiar, thought-provoking, and mystical scenes and characters inspired by, among other things, nature and mythology.

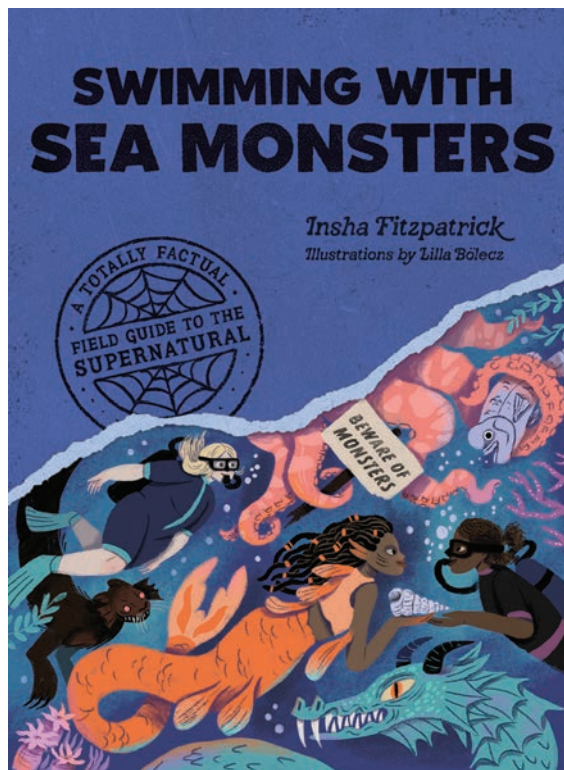

Subject:
Juvenile Nonfiction - Paranormal & Supernatural
Juvenile Nonfiction - History - General
Juvenile Nonfiction - Social Science - Folklore & Mythology

ISBN: 978-1-68369-435-9
\$14.99 USD
6 x 8, 128 pages,
4c paperback with flaps
Word Count: Approx 10,000 words
Age Range: 8-12 years

Rights Sold:
All world rights available.

Publication Date: August 26, 2025
Final PDF Available: April 2025
ARC PDF Available: Available Now

ABOUT THE SERIES

A funny and informative nonfiction series for curious readers, *A Totally Factual Field Guide to the Supernatural* explores the supernatural, extraterrestrial, and paranormal with a field guide approach to our world's myths and legends. Engrossing science and fascinating history come to life with charming illustrations, kid-friendly text, and educational hands-on activities.

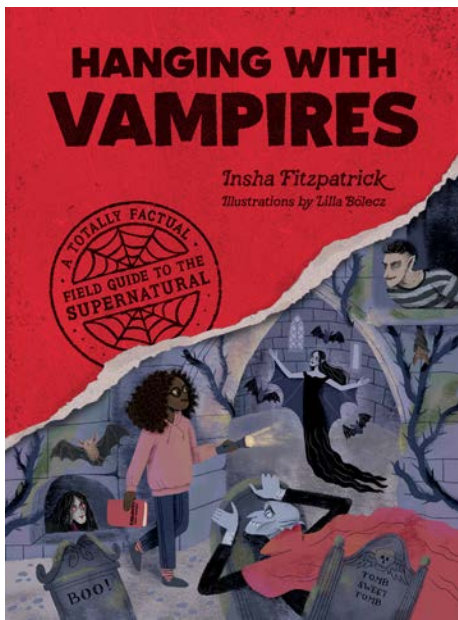
**Hanging with Vampires**

A Totally Factual Field Guide to the Supernatural

By Insha Fitzpatrick, illustrated by Lilla Bölec

Are vampires real? Who was Vlad the Impaler? Do vampire bats ever feed on humans? Find out in *Hanging with Vampires*, a field guide for the curious and the adventurous. Crack open the lid on this guide and you'll get:

- **Bloodcurdling vampire mythology!** What exactly is a vampire, anyway?
- **Spine-chilling history and science!** Uncover how the vampire legend got its start in the medieval ages.
- **A who's who of vampires!** Get to know classic, iconic, and terrifying vampires in pop culture, from *Dracula* to *Adventure Time*.

ISBN: 978-1-68369-341-3

Price: \$14.99 USD

Publication Date: March 2023

Rights Sold: Italian (Moscabianca), World Spanish (Siruela)

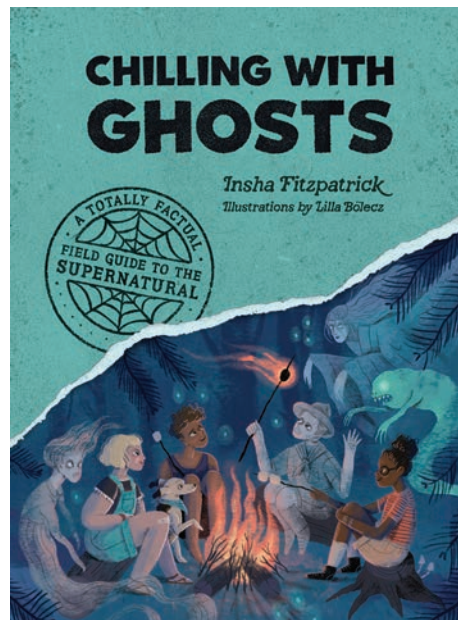
**Chilling with Ghosts**

A Totally Factual Field Guide to the Supernatural

By Insha Fitzpatrick, illustrated by Lilla Bölec

Boo! Do you believe in ghosts? What's up with haunted houses? And how exactly do you bust a ghost? Uncover the spooky and spectral world of ghosts in *Chilling with Ghosts*, a field guide for the curious and the adventurous. Step into the unknown—if you dare!—and discover:

- **Haunting history and super weird science!** Meet ghosts from ancient mythology and find out what exactly ghost fungus is.
- **Scary ghost stories of all kinds!** Meet the ghost of the renowned playwright William Shakespeare and craft your very own ghost story.
- **A globe-trotting tour of haunted spots!** Travel all around the world, from the Catacombs of Paris to the Winchester Mystery House.

ISBN: 978-1-68369-345-1

Price: \$14.99 USD

Publication Date: August 2023

Rights Sold: Italian (Moscabianca)

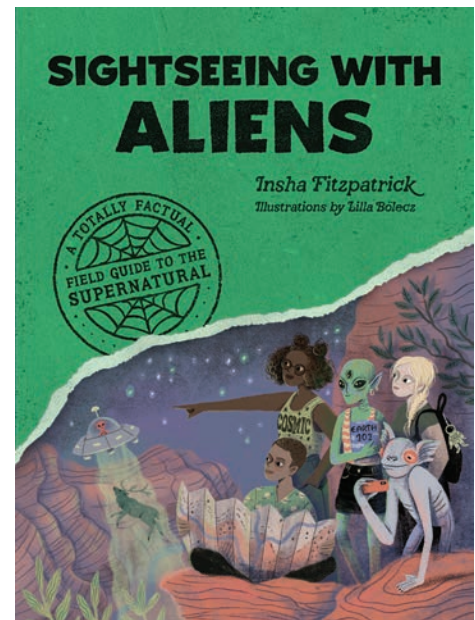
**Sightseeing with Aliens**

A Totally Factual Field Guide to the Supernatural

By Insha Fitzpatrick, illustrated by Lilla Bölec

Are aliens out there? What's the deal with Area 51? Can outer space support human life? Blast off to space with *Sightseeing with Aliens* and discover:

- **Cool science and eye-opening history!** Learn about the past, present, and future of space exploration.
- **Strange accounts of alien encounters!** Dig into the truth behind UFO sightings, crop circles, extraterrestrial events, and more.
- **Hands-on activities to try at home!** Create a time capsule and learn how to advocate for the environment.

ISBN: 978-1-68369-427-4

Price: \$14.99 USD

Publication Date: August 2024

Rights Sold: All world rights available.

Kid Olympians: Winter

By Robin Stevenson, Illustrated by Allison Steinfeld

Triumphant, relatable, and totally true biographies tell the childhood stories of a diverse group of international athletes who have captured the world's attention at the Winter Olympics, like Johnny Weir, Chloe Kim, Apolo Anton Ohno, Surya Bonaly, and twelve other inspiring Olympians.

- **Michelle Kwan**, who used to sleep in her skating clothes to get a few extra minutes of sleep before her lessons at dawn!
- **Cindy Ouellet**, one of the few athletes to have competed in both the Winter and Summer Paralympics.
- **Apolo Ohno**, who started skating because he thought the speed skaters looked like superheroes!

The diverse and inspiring group also includes Callan Chythlook-Sifsof, Adam Rippon, Kristi Yamaguchi, Lindsey Vonn, Marie-Philip Poulin, Alex and Maia Shibutani, Shani Davis, Charles Flaherty, Maame Biney, and Nathan Chen.



ROBIN STEVENSON is an award-winning author of more than twenty books for kids and teens. Her writing has been translated into a number of languages, published in more than ten countries, and nominated for many awards.

Her YA novel, *A Thousand Shades of Blue*, was a finalist for Canada's top literary honor, the Governor General's Award. Her YA nonfiction book, *Pride*, was a Stonewall Honor book and was selected to ALA's Rainbow List. She lives with her family on the west coast of Canada.



ALLISON STEINFELD obtained a BFA from the School of Visual Arts in New York City. She loves to create fun and playful work that can be enjoyed by readers of all ages. She lives in Atlanta, Georgia.



Featuring kid-friendly text and full-color illustrations, readers ages 8-12 will be inspired to dream bigger, faster, and higher than ever before!

Subject:
 Juvenile Nonfiction - Sports & Recreation - Olympics & Paralympics
 Juvenile Nonfiction - Biography & Autobiography - Sports & Recreation
 Juvenile Nonfiction - Biography & Autobiography - Social Activists

ISBN: 978-1-68369-393-2
Price: \$14.99 USD
 5½ x 8, 240 pages,
 4c unjacketed hardcover
Age Range: 8-12
Word count: Approx. 25,000 words
Illustrations: Approx. 200 4c illustrations.

Rights Sold: All world rights available.

Publication Date: November 11, 2025
Final PDF Available: April 2025
Sample MS: Available Now

Kid Legends Series

Before they were famous, they were kids, struggling with regular-kid problems like bullies, homework, and arguments with their siblings. Inspiring anecdotes and playful illustrations reveal the relatable childhood escapades of celebrated presidents, great athletes, groundbreaking scientists, and other future legends.

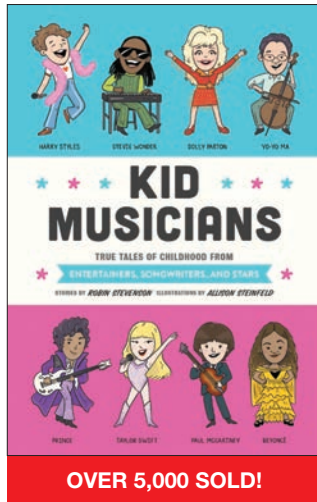

Kid Musicians
ISBN 978-1-68369-391-8
5½ x 8, 224 pages, 4c hardcover
Publication Date: January 2024



Kid Olympians: Summer
ISBN 978-1-68369-371-0
5½ x 8, 240 pages, 4c hardcover
Publication Date: January 2024



Kid Trailblazers
ISBN 978-1-68369-301-7
\$14.99 USD
5½ x 8, 224 pages, 4c hardcover
Publication Date: August 2022



Kid Innovators
ISBN 978-1-68369-227-0
\$14.99 USD
5½ x 8, 208 pages, 4c hardcover
Publication Date: February 2021

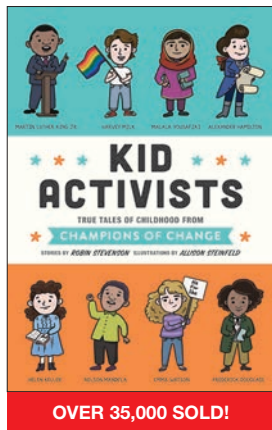

Kid Activists
ISBN 978-1-68639-141-9
5½ x 8, 224 pages, 4c hardcover
Publication Date: September 2019



Kid Scientists
ISBN 978-1-68639-074-0
5½ x 8, 208 pages, 4c hardcover
Publication Date: October 2018

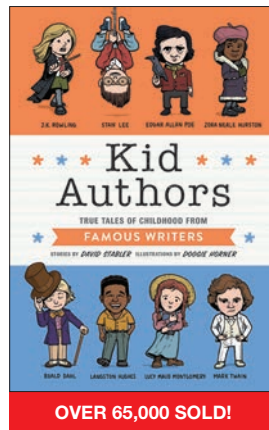

Kid Authors
ISBN 978-1-59474-987-2
5½ x 8, 200 pages, 4c hardcover
Publication Date: October 2017

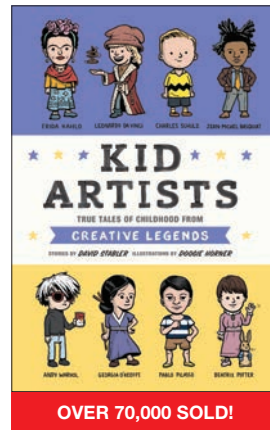

Kid Artists
ISBN 978-1-59474-896-7
5½ x 8, 208 pages, 4c hardcover
Publication Date: August 2016



Kid Athletes
ISBN 978-1-59474-802-8
5½ x 8, 208 pages, 4c hardcover
Publication Date: November 2015

Rights Sold: SIMP. CHINESE: Artists, Athletes (to Lijiang), Scientists, Authors (to TB) GREEK: Athletes, Artists, Innovators, Scientists (to Savalas) HEBREW: Authors, Artists (to Armchair) KOREAN: Scientists (to Greatbooks), Artists (to ReadySetGo) RUSSIAN: Scientists, Athletes (to Clever) SERBIAN: Scientists, Artists (to Vulkan) SPANISH: Scientists, Artists, Innovators, Activists, Musicians (to Siruela) TURKISH: Innovators, Scientists, Authors, Artists, Athletes (to Hep Kitap) VIETNAMESE: Scientists, Authors, Artists, Athletes, Summer Olympians (to KimDong).

Little Kid, Big City!

Kids pick their own path through the most exciting cities in the world in *Little Kid, Big City!* With fun and little-known facts about locations, a resource section of useful information, prompts to choose which way to travel next, and a foldout map of each city, this series will delight kids on the move or those who want to learn about far-flung locales from home.



Little Kid, Big City!: New York

By Beth Beckman; illustrated by Holly Maher

If you could have an adventure in New York City, where would you go?

Would you walk the Brooklyn Bridge for a huge slice of pizza, see the dazzling lights in Times Square, or visit the whale at the Museum of Natural History?

Create your own itinerary, choose which places to visit at the end of every page, and follow along with an adventurous family as they explore New York.

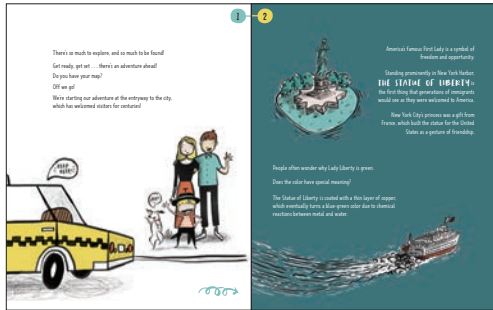

Little Kid, Big City!: London

By Beth Beckman; illustrated by Holly Maher

If you could have an adventure in London, where would you go?

Would you hop on the Tube to visit Buckingham Palace, find a tasty lunch on Brick Lane, or pass the time with Big Ben?

Create your own itinerary, choose which places to visit at the end of every page, and follow along with an adventurous girl and her two moms as they explore London.



BETH BECKMAN is the editor and founder of the namesake website, Little Kid, Big City, and is trusted by parents across the country as an authority on traveling with kiddos.



HOLLEY MAHER is the celebrated stationery designer behind Wink Wink Paper Co, as well as a songwriter and recording artist. She lives in Nashville, Tennessee, with a lazy dog named Booker. You can find her online at holleymaher.com.

Little Kid, Big City!: New York

ISBN 978-1-68369-244-7

\$19.99 USD

8 x 10, 88 pages
4c unjacketed hardcover with fold-out poster

Age Range: 8-12

Rights Sold: Galician (Bululú), Spanish (Bululú)

Publication Date: February 2021

Little Kid, Big City!: London

ISBN: 978-1-68369-248-5

\$19.99 USD

8 x 10, 88 pages
4c unjacketed hardcover with fold-out poster

Age Range: 8-12

Rights Sold: Galician (Bululú), Spanish (Bululú)

Publication Date: June 2021



Pet That Dog!

By Gideon Kidd and Rachel Braunigan, illustrated by Susann Hoffmann

A guide for young readers to befriend and care for dogs of all shapes, sizes, and personalities. This kid-friendly handbook pairs joyful illustrations with an interactive format. With step-by-step guides, fascinating stories, and helpful tips, *Pet That Dog!* makes a perfect gift for dog-curious kids and dog lovers of all ages.

ISBN 978-1-68369-229-4

\$14.99 USD

6 x 8, 128 pages

4c paperback

Age Range: 7 and up

Rights Sold: Hungarian (Kossuth)

Publication Date: October 2020



Pet That Cat!

By Nigel Kidd and Rachel Braunigan, illustrated by Susann Hoffmann

A fun and informative handbook for young readers on understanding and caring for our feline friends. This kid-friendly handbook pairs charming illustrations with an interactive format. With step-by-step guides, fascinating stories, and tips from cat experts and Nigel, *Pet That Cat!* is a must-have handbook for feline fans of all ages.

ISBN 978-1-68369-314-7

\$14.99 USD

6 x 8, 128 pages

4c paperback

Age Range: 7 and up

Rights Sold: Czech (Albatros)

Publication Date: July 2022

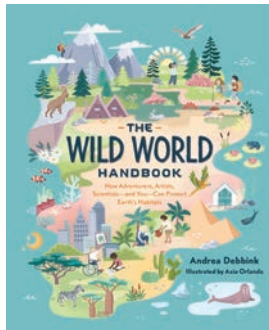

The Wild World Handbook: Habitats

By Andrea Debbink, illustrated by Asia Orlando

Packed with real-life tales of adventure, breathtaking illustrations, and hands-on STEAM activities, this handbook is an inspiring guide for the next generation of climate activists, conservationists, and nature lovers.

The first book in a middle grade series for young environmental activists and nature lovers, *The Wild World Handbook: Habitats* offers a roadmap for change and an invitation to explore the outdoors, alongside surprising facts and hands-on STEAM activities. Featuring nine habitats from around the globe, each section includes diverse biographies of outdoor adventurers, scientists, and artists who used their passion and skills to become bold allies for Earth's natural diversity and resiliency.

ISBN 978-1-68369-246-1

\$19.99 USD

6 1/2 x 8 1/2, 232 pages

4c paperback

Age Range: 8-12

Rights Sold: Serbian (Blum/Kalipso)

Publication Date: May 2021

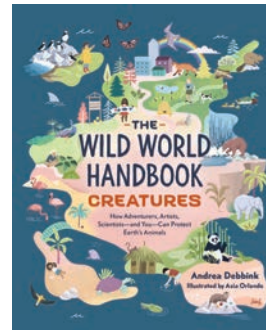

The Wild World Handbook: Creatures

By Andrea Debbink, illustrated by Asia Orlando

We share this incredible planet we call home with countless living creatures, from butterflies and falcons to koalas and dolphins. And just like us, animals everywhere are faced with the growing threat of climate change.

Featuring seven categories of creatures, this handbook offers a roadmap for change and an invitation to explore the outdoors with fascinating facts, hope-filled stories, and hands-on STEAM activities. Each chapter highlights the biographies of scientists, artists, and adventurers from diverse backgrounds who have used their passion and skills to become courageous advocates for animals around the world.

ISBN 978-1-68369-268-3

\$19.99 USD

6 1/2 x 8 1/2, 192 pages

4c paperback

Age Range: 8-12

Rights Sold: Serbian (Blum/Kalipso)

Publication Date: November 2021

Girls Resist!

A Guide to Activism, Leadership, and Starting a Revolution

By KaeLyn Rich

An activism handbook for teen girls ready to fight for change, social justice, and equality.

Take on the world and make some serious change with this handbook to everything activism, social justice, and resistance. With in-depth guides to everything from picking a cause, planning a protest, and raising money to running dispute-free meetings, promoting awareness on social media, and being an effective ally, *Girls Resist!* will show you how to go from “mad as heck about the way the world is going” to “effective leader who gets stuff done.” Veteran feminist organizer KaeLyn Rich shares tons of expertise that’ll inspire you as much as it teaches you the ropes. Plus, quotes and tips from fellow teen girl activists show how they stood up for change in their communities. Grab this handbook to crush inequality, start a revolution, and resist!



KAELYN RICH is a staff writer for popular queer women’s website Autostraddle.com. A queer feminist, direct action organizer, and sexuality educator, she is the Assistant Advocacy Director of the American Civil Liberties Union of New York and the former community affairs coordinator for Planned Parenthood of Central and Western New York. She lives with her spouse, their new baby, and a house full of pets.

- **A Wall Street Journal Pick for Teen Activism**
- **“Likely to become a go-to resource for young activists.”**
—PUBLISHERS WEEKLY, STARRED REVIEW
- **“Rousing and truthful . . . Rich is real with readers in a way that’s refreshing. . . . A smart tool to fight inequity.”**
—BOOKLIST



Subject:
Young Adult Nonfiction - Girls & Women
Young Adult Nonfiction - Social Topics - Civil & Human Rights
Young Adult Nonfiction - Social Science - Politics & Government

ISBN: 978-1-68369-059-7
\$14.99 USD
5½ x 7 ½, 240 pages,
2c paperback with flaps, lightly illustrated throughout
Word Count: Approx 40,000 words
Age Range: 14 and up

Rights: Hungarian (expired), Japanese (Shobunsha), Korean (expired), Polish (expired), Portuguese (expired)

Publication Date: August 2018



Wonder Women: 25 Innovators, Inventors, and Trailblazers Who Changed History

You may think you know women's history pretty well. But have you ever heard of:

- Alice Ball, the chemist who developed an effective treatment for leprosy—only to have the credit taken by a man?
- Mary Sherman Morgan, the rocket scientist whose liquid fuel compounds blasted the first U.S. satellite into orbit?
- Huang Daopo, the inventor whose weaving technology revolutionized textile production in China—centuries before the cotton gin?

Smart women have always been able to achieve amazing things, even when the odds were stacked against them. In *Wonder Women*, author Sam Maggs tells the stories of the brilliant, brainy, and totally rad women in history who broke barriers as scientists, engineers, mathematicians, adventurers, and inventors.

Publication Date: October 2016
 ISBN 978-1-59474-925-4
 \$16.99 USD
 5 x 7½, 240 pages
 2c hardcover with jacket
Rights Sold: Brazilian Portuguese (expired), Turkish (Butik)

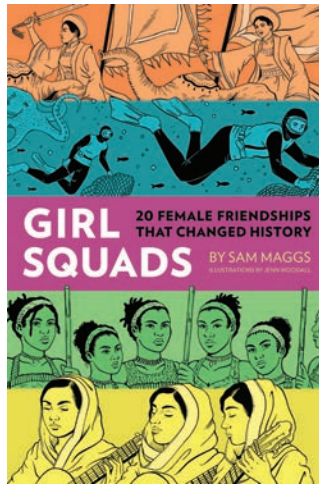

Girl Squads: 20 Female Friendships that Changed History

Spanning art, science, politics, activism, and sports, these 20 diverse profiles show just how essential female friendships have been across history and around the world. In this engaging and well-researched book, Sam Maggs takes you on a tour of some of history's most fascinating and bravest BFFs, including:

- Anne Bonny and Mary Read, the infamous lady pirates who sailed the seven seas and plundered with the best of the men
- Jeanne Manon Roland and Sophie Grandchamp, Parisian socialites who landed front-row seats (from prison) to the French Revolution
- The Zohra Orchestra, the ensemble from Afghanistan who defied laws, danger, and threats to become the nation's first all-female musical group

Fun, informative, and delightful to read—with fresh illustrations by Jenn Woodall—it's perfect for you and every member of your own girl gang.

Publication Date: October 2018
 ISBN 978-1-68369-072-6
 \$16.99 USD
 5 x 7½, 272 pages
 2c hardcover with jacket
Rights Sold: Korean (expired)



The Fangirl's Guide to the Universe: A Handbook for Girl Geeks

From notable geek girl Sam Maggs, *The Fangirl's Guide to the Universe* is the ultimate handbook for teens living the nerdy life.

Fandom, pop culture, feminism, cosplay, cons, books, memes, podcasts, vlogs, OTPs and RPGs and MMOs and more—there's never been a better time to be a fangirl, or a better guide to navigate the wide universe of fandoms. This handbook is packed with tips, playthroughs, and cheat codes, including:

- How to make nerdy friends
- How to rock cosplay
- How to write fanfic with feels
- How to defeat internet trolls
- How to attend your first con

And more!

Publication Date: October 2020
 ISBN 978-1-68369-231-7
 \$15.99 USD
 5½ x 7½, 208 pages
 2c hardcover with jacket
Rights Sold: Audio



SAM MAGGS is a best-selling author of books, comics, and video games. She's the author of *Wonder Women*, *Girl Squads*, *The Fangirl's Guide to the Universe*, and *The Fangirl's Guide to Leveling Up*, as well as many YA and middle-grade titles like *Unstoppable Wasp: Built on Hope*, *Con Quest!*, and *Tell No Tales*; a senior games writer, including work on Marvel's *Spider-Man*; and a comics writer for titles like *Marvel Action: Captain Marvel*, *My Little Pony*, and *Transformers*. She is also an on-air host for networks like Nerdist. A Canadian in Los Angeles, she misses Coffee Crisp and bagged milk. Visit her online at sammaggs.com or @SamMaggs!

Gay The Pray Away

By Natalie Naudus

“Achingly heartfelt and resoundingly beautiful. I need more books from Natalie Naudus ASAP!”

—Julie Abe, author of *The Charmed List* and *Our Cursed Love*

Valerie Danners is in a cult. She just doesn't know it yet. But when she stumbles upon a queer romance novel at the library, everything about her life—a fundamentalist Christian homeschooling group—is thrown into question.

And to make things even more complicated, there's a new girl in town. Riley is rebellious, kindhearted, and impossibly cool. As the two bond over being multiracial teens in their very white and very religious community, Valerie finds herself falling in love.

Soon Valerie and Riley are exchanging notes in secret and stealing kisses behind the church. But even as their romance blooms, Valerie knows that they're trapped. If Valerie wants a chance at writing her own story, she must choose between staying with a family she fears will never accept her or running away with the girl she loves.



NATALIE NAUDUS is one of the most beloved audiobook narrators working today. She has won an Audie award and nine Earphones awards and maintains a robust social media following. She lives with her family on a mountain in Virginia.

In this gripping queer YA romance perfect for fans of Casey McQuiston and Becky Albertalli, an Asian American teen longs to break free of the conservative cult she was raised in.

“Composed with equal parts sweetness, care, and stubborn queer perseverance.”

—**CASEY McQUISTON**, #1 *New York Times* best-selling author of *Red, White & Royal Blue*



Subject:

Young Adult Fiction - Coming Of Age

Young Adult Fiction - Romance - LGBTQ+

Young Adult Fiction - Asian American & Pacific Islander

ISBN 978-1-68369-511-0

\$12.99 USD

5½ x 8, 256 pages,
1c paperback

Age Range: 14 and up

Rights: All translation rights available. Film & audio reserved to author.

Publication Date: May 20, 2025

Final PDF Available: Available Now

Stars, Hide Your Fires

By Jessica Mary Best

A sapphic sci-fi mystery for fans of *Iron Widow* and *The Darkness Outside Us*.

As an expert thief from a minor moon, Cass knows a good mark when she sees one. The emperor's ball is her chance to steal a fortune for herself, her ailing father, and her scrappy crew of thieves and market vendors.

Her plan is simple:

1. Hitch a ride to the planet of Ouris, the dazzling heart of the empire.
2. Sneak onto the imperial palace station to attend the emperor's ball.
3. Steal from the rich, the royal, and the insufferable.

But on the station, things quickly go awry. When the emperor is found dead, everyone in the palace is a suspect—and someone is setting Cass up to take the blame. To clear her name, Cass must work with an unlikely ally: a gorgeous and mysterious rebel with her own reasons for being on the station. Together, they unravel a secret that could change the fate of the empire.



JESSICA MARY BEST is a multi-award-winning freelance writer/editor, an amateur singer/songwriter, and a well-intentioned ball of pure quivering anxiety. She is based out of Columbus, Ohio.

Praise for *Stars, Hide Your Fires*

"Rich with inviting detail, this genre-blending adventure smorgasbord features socially conscious commentary regarding financial disparity and an intricate plot that's equal parts sci-fi, murder mystery, and fast-paced thriller. A sweet, gently played romance and a widely utilized, intersectionally diverse cast add nuance to Best's tantalizing debut."—*Publishers Weekly*, starred review

"Descriptive worldbuilding, inventive and gender-inclusive slang and symbolism, a vividly drawn cast, and fast-paced banter are joined by nonstop action and twisty revelations . . . a high-stakes murder-mystery science-fiction thrill ride; great fun."—*Kirkus Reviews*



7,500 COPIES SOLD

"A DELIGHTFULLY MISCHIEVOUS ADVENTURE FULL OF INTRIGUE, BETRAYAL, AND A TOUCH OF ROMANCE. GET READY TO JOIN YOUR NEW FAVORITE REBEL CREW."
—DAHLIA ADLER, AUTHOR OF *COOL FOR THE SUMMER*

Coming March 2026 from Jessica Best: *You Pierce My Soul*

Packed with shocking plot twists and sapphic yearning, *You Pierce My Soul* is a romantic and thrilling queer dystopian YA perfect for fans of Malinda Lo and Rachael Lippincott.

Subject:

Young Adult Fiction - Science Fiction - Space Opera
Young Adult Fiction - Mysteries & Detective Stories
Young Adult Fiction - Romance - LGBTQ+

ISBN 978-1-68369-434-2

\$10.99 USD

5½ x 8, 304 pages,
1c paperback

Word count: Approx 70,000 words

Rights Sold:

Audio: (Blackstone)

Publication Date: July 2023

Lycanthropy and Other Chronic Illnesses

By Kristen O'Neal

Teen Wolf meets *Emergency Contact* in this sharply observed, hilarious, and heartwarming debut young adult novel about friendship, chronic illness, and . . . werewolves.

Priya worked hard to pursue her medical school dreams at Stanford, but a diagnosis of Lyme disease during her sophomore year sends her back to her loving but overbearing family in New Jersey—and leaves her wondering if she'll ever be able to return to the way things were. Thankfully she has her online pen pal, Brigid, and the rest of the members of “oof ouch my bones,” a virtual support group that meeets on Discord to crack jokes and vent about their own chronic illnesses.

When Brigid suddenly goes offline, Priya does something out of character: she steals the family car and drives to Pennsylvania to check on Brigid. Priya isn't sure what to expect, but it isn't the horrifying creature that's shut in the basement. With Brigid nowhere to be found, Priya begins to puzzle together an impossible but obvious truth: the creature might be a werewolf—and the werewolf might be Brigid. As Brigid's unique condition worsens, their friendship will be deepened and challenged in unexpected ways, forcing them to reckon with their own ideas of what it means to be normal.



KRISTEN O'NEAL is a freelance writer has written for sites like BuzzFeed Reader, Christianity Today, LitHub, Birth.Movies.Death, and Electric Literature. She lives on the internet. You can find her at @Kristen_ONeal on Twitter and kristenoneal on Tumblr. *Lycanthropy and Other Chronic Illnesses* is her first novel.

Praise for *Lycanthropy and Other Chronic Illnesses*

“At its core, the novel feels like a love letter to the internet communities that connect people; it's a reminder that friendships, both virtual and in-person, can save lives.”

—Maya Van Wagenen, *New York Times*

“Emotional, thoughtful, and a true testament to the power of friendship, *Lycanthropy and Other Chronic Illnesses* is a werewolf novel that will make you look at navigating illness, supernatural or not, in a whole new way. . . .”

—*Locus Magazine*

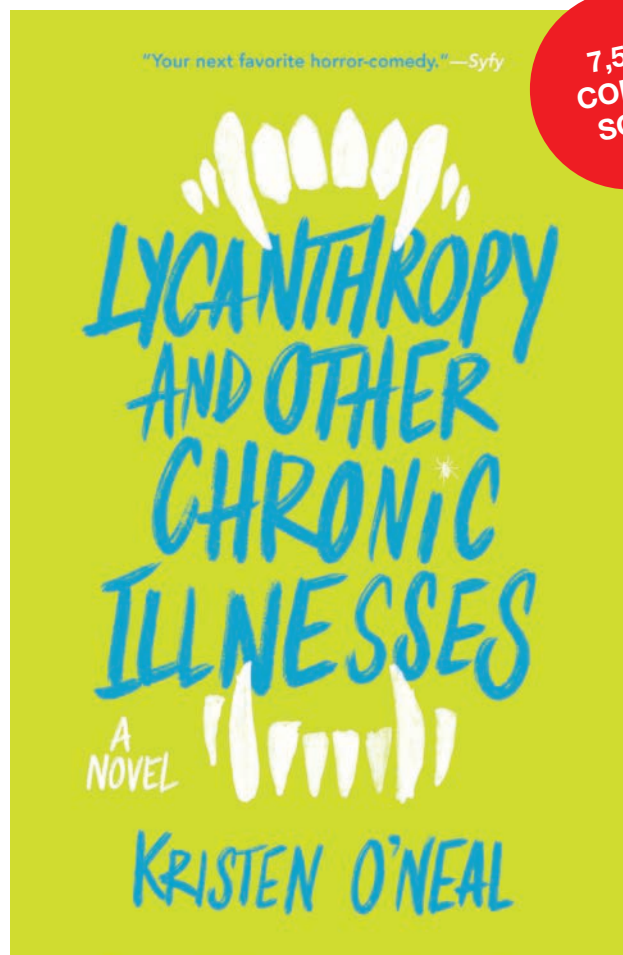

“A funny, heartfelt book with a phenomenal premise.”

—*NEW YORK TIMES*

Subject:

Young Adult Fiction - Social Themes
- Friendship
Young Adult Fiction - Humorous - General
Young Adult Fiction - Werewolves & Shifters

ISBN 978-1-68369-307-9

\$10.99 USD

5¼ x 8, 384 pages,
1c paperback

Word count: Approx 80,000 words

Age Range: 14 and up

Rights Sold: Audiobook (Recorded Books). All translation rights available.

Publication Date: April 2021

YA Romance from Ashley Poston: The Once Upon A Con Series

Your favorite fairy tales take to the page as geeky, funny, and adorably romantic contemporary YA novels. A handsome sci-fi prince falls for a passionate fangirl. Hollywood's geeky leading lady swaps places with an ordinary con-going girl who could be her twin. Hijinks, hilarity, and sweet love stories ensue. Perfect for contemporary YA fans, geeks, cosplayers, and any readers who believe in the magic of fandom.

OVER
150,000
SOLD!



Cinderella goes to the con in this fandom-fueled twist on the classic fairy tale romance.



The Prince and the Pauper gets a *Geekarella*-style makeover in this witty and heartfelt novel.



A tale as old as time is made new in Ashley Poston's fresh, geeky retelling of *Beauty and the Beast*.

Active Rights Sold: French (Lumen), Serbian (Odiseja), Spanish (Planeta México), Yabancı (Turkish)

Expired: Indonesian, Korean, Polish, Brazilian Portuguese, Romanian, Russian, Vietnamese

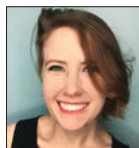

ASHLEY POSTON is a *New York Times* and *USA Today* best-selling novelist who writes cozy and magical love stories. Her young adult novels have been nominated for the Indie Next List, the Goodreads Choice Awards, and have been featured in countless articles and recommended reading lists.

Dystopian from Anna Carey

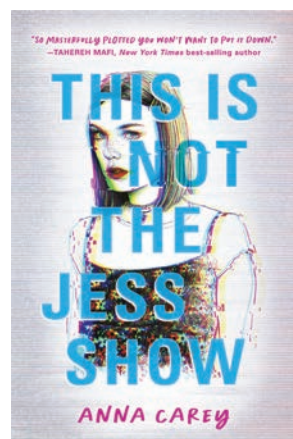

A teenage girl's reality may not be what it seems in *This Is Not the Jess Show*, a riveting young adult thriller duology blending '90s nostalgia with a speculative hook that dissects our reality TV and influencer-obsessed culture. Perfect for readers of *We Were Liars* and *One of Us Is Lying*.

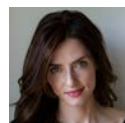

ANNA CAREY is the author of several books for teens including *This Is Not the Jess Show*, *This Is Not the Real World*, and the Eve trilogy. She lives in Los Angeles.

Miss Peregrine's Peculiar Children Series

Published by Quirk Books in 2011, *Miss Peregrine's Home for Peculiar Children* follows sixteen-year-old Jacob Portman as he journeys from a sleepy Florida suburb to a remote island off the coast of Wales. There he stumbles upon the ruins of Miss Peregrine's orphanage and discovers the shocking fate of the children who lived there long ago—and may live there still.

Miss Peregrine's Home for Peculiar Children was followed by two best-selling sequels, *Hollow City* and *Library of Souls*. All three novels are illustrated with dozens of vintage found photographs.

**OVER
10 MILLION
COPIES
SOLD!**

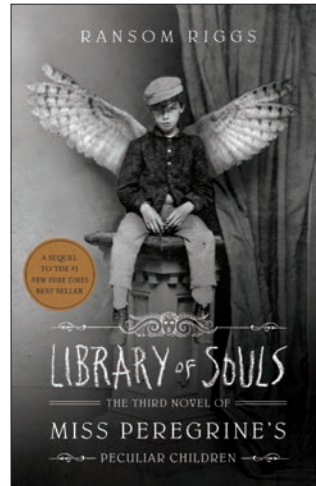
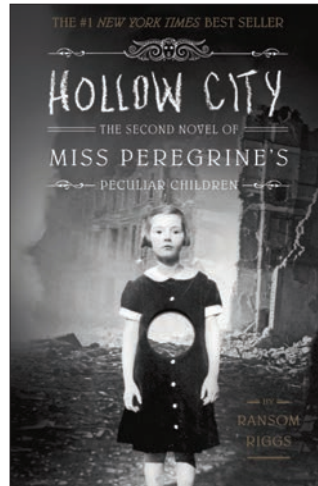
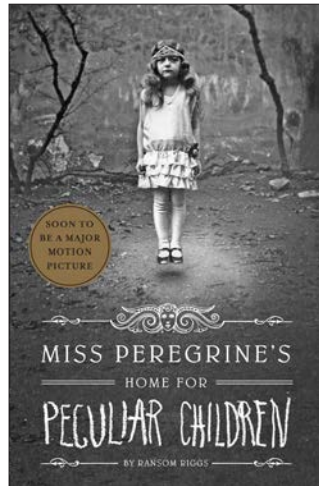

SAMPLE SPREADS



Rights:

Audio: PRH Audio (Volume 1), Blackstone (Volumes 2 and 3)

Film/TV: A major motion picture from 20th Century Studios, directed by Tim Burton

Translation:

Active: Albanian (Pegj), Armenian (Arevik), Catalan (L'Altra), Simp. Chinese (Huaxia Winshare), Trad. Chinese (Global Group), Croatian (Lumen), Czech (Jota), Dutch (Clavis), French (Bayard), German (Droemer), Italian (Rizzoli), Korean (Hyundaemunhak), Lithuanian (Alma Littera), Polish (Media Rodzina), Brazilian Portuguese (Intrinseca), Romanian (ART), Sinhalese (Favorite), Spanish (Planeta), Swedish (Rabén & Sjögren), Turkish (Ithaki), Vietnamese (Nha Nam)

EXPIRED & AVAILABLE FROM QUIRK: Azerbaijani (TEAS), Bulgarian (BARD), Estonian (Tiritamm), Finnish (SETS), Hungarian (Kossuth), Japanese (Ushio), Latvian (Zvaigzne), Macedonian (Toper), Mongolian (Bolor Sudar), Norwegian (Schibsted), Persian (Parian), Portuguese in Europe (Bertrand), Serbian (Orfelin), Slovak (Albatros), Slovenian (Sanje), Thai (Amarin),

Miss Peregrine's Home for Peculiar Children

ISBN 978-1-59474-476-1
\$18.99 USD
5 3/8 x 8 3/8, 352 pages,
2c hardcover with jacket

Hollow City

ISBN 978-1-59474-612-3
\$18.99 USD
5 3/8 x 8 3/8, 352 pages,
2c hardcover with jacket

Library of Souls

ISBN 978-1-59474-758-8
\$18.99 USD
5 3/8 x 8 3/8, 400 pages,
2c hardcover with jacket

Miss Peregrine's Home for Peculiar Children Movie Tie-In Edition

ISBN 978-1-59474-902-5
\$11.99 USD
5 3/8 x 8 3/8, 384 pages,
1c paperback



RANSOM RIGGS is the #1 *New York Times* best-selling author of the *Miss Peregrine's Peculiar Children* novels. Riggs was born on a farm in Maryland and grew up in southern Florida. He studied literature at Kenyon College and film at the University of Southern California. He lives in Los Angeles with his wife, the best-selling author Tahereh Mafi, and their family.

2026-2027 TEASERS**LET'S FIND YAYA AND BOO ON THE FARM!**

by Andrew Knapp

Is that Yaya sitting in the hayloft, and Boo relaxing near the chicken coop? Can you spot the dogs riding in the back of a tractor or napping by the barn door? The newest addition to Andrew Knapp's beloved Find Momo series invites readers to explore the charm of farm life, with fields, orchards, animals, and equipment galore.

LET'S FIND YAYA AND BOO AT THE BEACH!

by Andrew Knapp

Is that Yaya perched on a lifeguard stand, and Boo peeking out from behind a beach chair? Can you spot the dogs walking along the shore or resting in the shade of a fishing boat? The latest installment in Andrew Knapp's beloved Find Momo series explores a day at the beach, featuring sunny strolls and seaside surprises.

CAT'S FIRST DAY OF SCHOOL

by Natalie Nelson

The next book in the beloved Dog and Cat's First series follows Cat as he observes all the excitement of Baby's first day of school! From the morning rush of backpacks and lunchboxes to the quiet hum of an empty house, Cat is ready to welcome Baby home after a big day. Celebrate the milestones, routines, and surprises of school days with Cat as Baby learns all about this exciting new experience!

CHAPTER BOOKS**ZOOMI AND ZOE AND THE CAMP CATASTROPHE**

by Corey Ann Haydu, illustrated by Anne Appert

Zoomi and Zoe are spending the summer at Camp GlumbleGlibble! While Zoe will only be away from earth for three looperos, or a few seconds in the human world, that's plenty of time to have the best summer ever with her best friend. Zoomi can't wait to show Zoe how to make friendship bracelets out of stars, and stay up late talking in their cabin that tells knock-knock jokes. But there are lots of Happy Helpful Humans at camp with their GlumbleGlibblers, and Zoe seems to have more in common with them than she does with Zoomi. Suddenly, Zoomi isn't sure of her place in GlumbleGlibble or with Zoe—and she definitely doesn't like feeling jealous or insecure. Can Zoomi and Zoe salvage the summer, and their friendship, after a big blowup?

MIDDLE GRADE**SHALLOW BAY #1: 16 STRANGE, SEMI-CONNECTED STORIES (PLUS 1 TOTALLY NORMAL ONE)**

by Genevieve Eugenia Pherese

Welcome to Shallow Bay, a small town with big dreams! Founded in the past by a person, or possibly multiple people, Shallow Bay can't be contained to one spot on a map—because it lives in the hearts and minds of its lovely citizens. Additionally, it simply refuses to be mapped, even when asked politely.

Scary Stories to Tell In The Dark meets *Wayside School* in this oddball middle grade short story collection about the curious residents and strange occurrences of Shallow Bay—a town you may never want to leave, or may never be able to leave.

YOUNG ADULT**YOU PIERCE MY SOUL**

by Jessica Mary Best

In the utopian city of New Ionia, everyone gets a soulmate—and Zada can't wait for hers. Now that she's eighteen, it's her turn to meet her destiny with the help of Heartsong, an algorithm that chooses your perfect match for you.

Then Zada crashes into her soulmate, setting off their shared Heartsong, and the unthinkable happens: she feels nothing for him. But the Heartsong program doesn't make mistakes, and by the end of the night, Zada is engaged to a man she doesn't love.

Desperate for a way out, Zada turns to her beautiful, reckless, and utterly impossible former best friend Daphne. Together, the two embark on a quest for the truth that throws Heartsong – and their entire world – into question. As time runs out, Zada must find the courage to choose what she believes and who she loves.

Contact Info

OUR INTERNATIONAL RIGHTS SUBAGENTS

Balkan Territory, Croatian, Romanian, and Slovenian

Olivia Dobra
Livia Stoia Literary Agency
olivia.dobra@liviastoiagency.ro.

Simplified Chinese, Malaysian, and Vietnamese

Wendy King
Big Apple Agency - Shanghai
Wendy-king@bigapple1-china.com

Traditional Chinese

Chris Lin
Big Apple Agency - Taipei
chris-lin@bigapple1-china.com

Czech, Slovak, Estonian, Latvian, and Lithuanian

Josef Kolar
JOSEF KOLAR: Foreign Rights Sales
josef.kolar65@gmail.com

Dutch, French, Scandinavian Territories

Chrysothemis Arnefti
2 Seas Agency
hello@2seasagency.com

German

Niclas Schmoll
Michael Meller Literary Agency
n.schmoll@melleragency.com

Greek

Avgi Daferera
Ersilia Literary Agency
childrensbooks@ersilialit.com

Hungarian

Margit Gruber
DS Budapest Kft.
margit@dsbudapest.hu

Indonesian

Yani Kurniawan
Literasia
yani@literasia.net

Italian

Rossano Trentin
Trentin Agency
rossano@trentinagency.com

Japanese

Takeshi Oyama
Japan UNI Agency Inc.
takeshi.oyama@japanuni.co.jp

Polish

Kamila Kanafa
Magda Cabajewska
Macadamia Literary Agency
info@macadamialit.com

Russian

Tatiana Vaniat
ICSTI
tatyana.vaniat@yandex.ru

Spanish/Portuguese

Íñigo Cebollada
Ute Körner Literary Agent, S.L.U.
i.cebollada@uklitag.com

Thai

Winnie Waropas
RTA Rights Agency
winnie.rightthingagency@gmail.com

Turkish

Ayşenur Tural
AnatoliaLit Agency
aysenur@anatolialit.com.

For all other territories please email:
rights@quirkbooks.com

QUIRK BOOKS CONTACTS

For general information about Quirk and our books—or to hear some darn good on-hold music—call 215-627-3581. Or fax us at 215-627-5220.

For more specific information:

Chairman and Founder

David Borgenicht
david@quirkbooks.com

Executive Vice President, Deputy Publisher

Nicole De Jackmo
nicole@quirkbooks.com

Assistant Director, Subsidiary Rights

Katherine McGuire
rights@quirkbooks.com

Senior Sales Manager

Kate Brown
kbrown@quirkbooks.com

Find book and art submission instructions at
quirkbooks.com/submissions
Check us out on the web at
quirkbooks.com

Learn how to fend off a shark at
worstcasescenario.com

Follow us:



/quirkbooks

Quirk Books
215 Church Street
Philadelphia, PA 19106

